



Thank you for purchasing a Borla Performance Cat-Back™ Exhaust System.

Precision manufactured using aircraft quality T-304 stainless steel; this system is designed to endure years of heavy use. Installing a Borla Performance Exhaust System on your vehicle will eliminate the restrictive design of the stock exhaust, allowing your engine to discharge exhaust gas easier. The result is more horsepower and torque, longer engine life, and a distinctive throaty growl- all this, with easy bolt-on installation. These installation instructions have been written to help you in the installation of your Borla Performance Exhaust System. Please read it completely before installing your system.

This Borla Performance Cat-Back™ Exhaust System (Part number 140084) has been designed for the 2001-2005 BMW 325I/330 Ci/i, 2 and 4 door equipped with a 3.0L inline 6-cylinder engine and automatic or 5 and 6-speed automatic or manual transmissions.

Borla Performance Industries recommends that an exhaust shop or professional after market parts installer, who has all the necessary equipment, tools and experienced personnel needed for proper installation, should perform the installation of this system. However, if you decide to perform the installation, we recommend someone should help you. Ensure the installer uses all under car safety precautions including eye protection.

Please take time to read and understand the following...

By installing your Borla Performance Exhaust System, you indicate that you have read this document and you agree with the terms stated below.

It is the responsibility of the purchaser to follow all installation instruction guidelines and safety procedures supplied with your Borla Performance Exhaust System.

Borla Performance Industries assumes no responsibility for damages occurring from misuse, abuse, improper installation, improper operation, lack of responsible care, or all previously stated reasons resulting from incompatibility with other manufacturer's products and/or systems.

Included with your Borla Performance Exhaust System is a warranty card. Please read it carefully before you begin any work on your vehicle. If you should have any questions regarding our warranty policy, installation, or any other matter pertaining to your new Borla Performance Exhaust System, please give us a call at the number provided on the warranty card.

Borla Performance Cat-Back™ Bill of Materials

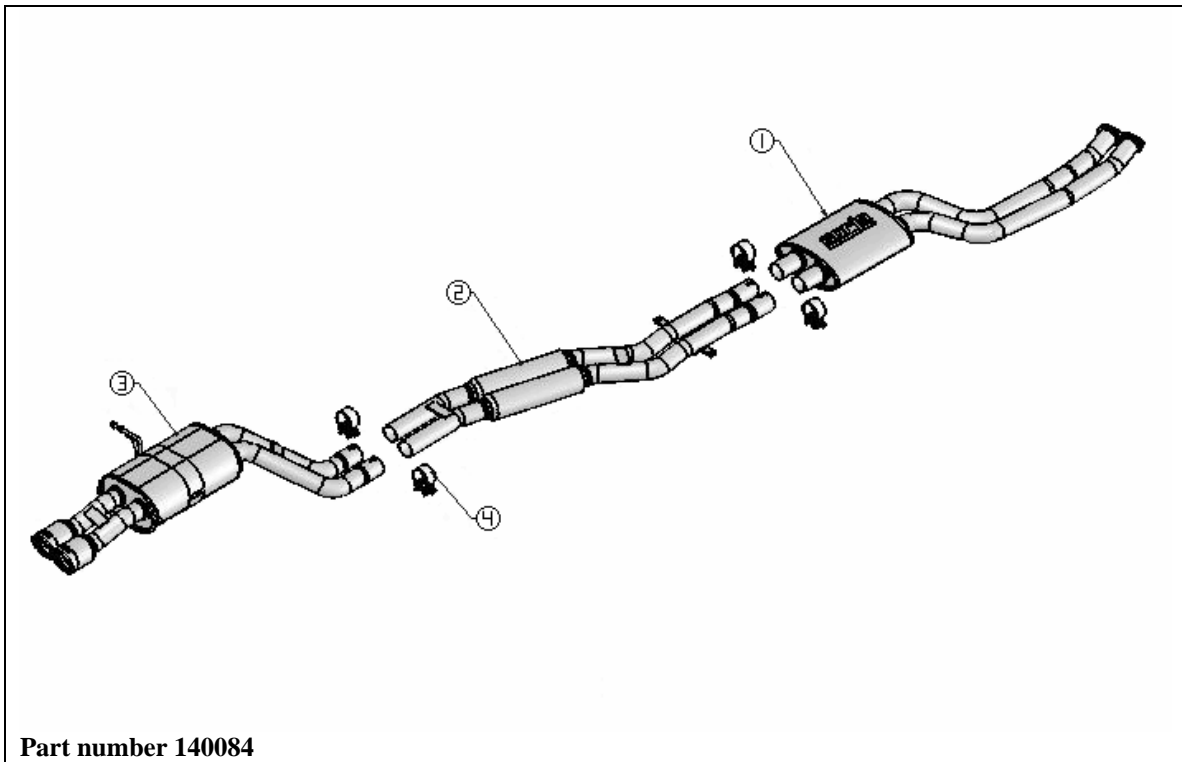

1. Front muffler assembly
2. Mid muffler assembly
3. Rear muffler assembly
4. 2.25" Accuseal™ clamp (qty 4)

Caution!!! Never work on a hot exhaust system. Serious injury in the form of burns can result If the vehicle has been in use and the exhaust system is hot, allow vehicle to cool for at least 1 hour. Always wear eye protection when working under any vehicle.

Note: It is our recommendation that you use a hoist or hydraulic lift to facilitate the installation of your new Borla Performance Cat-Back™ Exhaust System.

Taking all under car safety precautions, lift the vehicle using a hoist or hydraulic lift. Once this has been done, you may begin the removal of your old exhaust system from your vehicle.

Note: Before removing the original exhaust system from your vehicle, please compare the parts you have received with the bill of materials provided on the previous page to assure that you have all the parts necessary for the installation of your new Borla Performance Cat-Back™ Exhaust System.

Original Exhaust System Removal

Note: With a used vehicle, we suggest a penetrating spray lubricant to be applied liberally to all exhaust fasteners and allowing a significant period of time for the chemical to lubricate the threads before attempting to disassemble.

1. Unbolt and remove the front support brace and unbolt the rear support brace, both shown in figure 1 located just behind the front muffler. Place the hardware to the side for use during the installation of your new exhaust system.
2. Unbolt and remove the clamp portion of the exhaust bracket located ahead of the front muffler shown in figure 2.



Figure 1

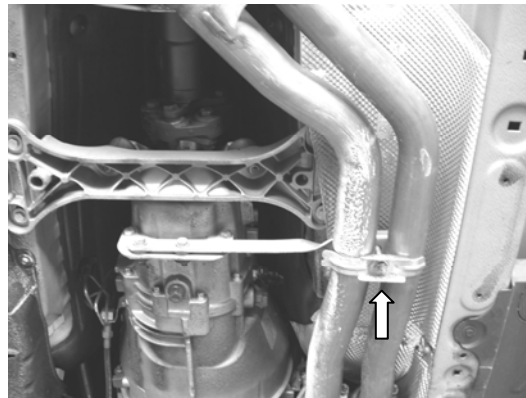

Figure 2

3. Unbolt the flanges shown in figure 3 located behind the catalytic converters. Place the hardware to the side for use during the installation of your new exhaust system.
4. On 330CI models, disconnect vacuum hose from valve assembly shown in figure 4. Plug hose using a vacuum plug (not included with system) or something similar.

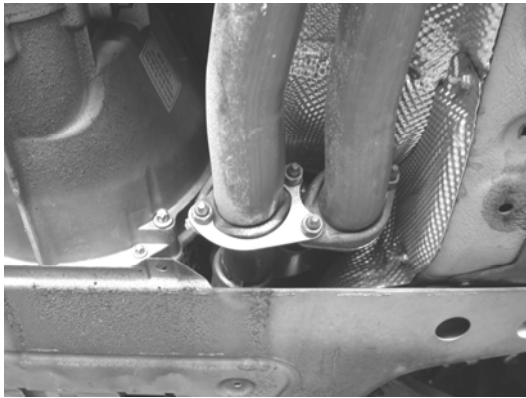

Figure 3

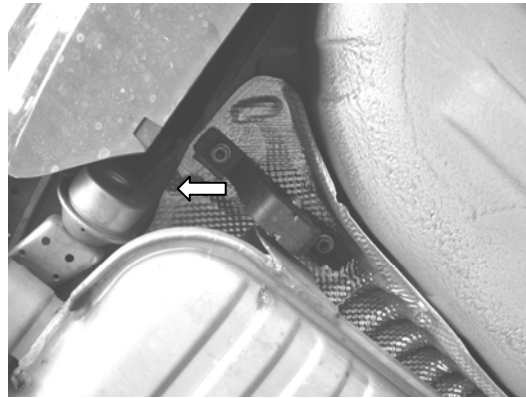

Figure 4

5. Using a muffler stand or an additional person to hold the exhaust system up in place, remove the two hangers located on each side of the rear muffler assembly, as the one shown in figure 5, by unbolting them from the vehicle.
6. Remove the exhaust from the vehicle as shown in figure 6.

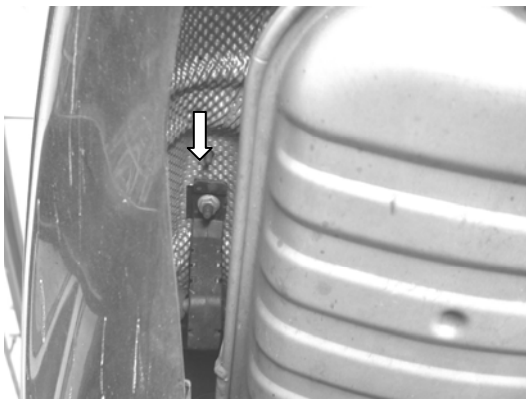

Figure 5



Figure 6

7. Unbolt and remove rear center support from the original exhaust as shown in figure 7 and set it and the hardware aside for use during the installation of your new exhaust system.



Figure 7

Borla Performance Cat-Back™ Exhaust System Installation

Warning: Use extreme caution during installation. Torque all fasteners according to manufacturer's torque values and tightening sequence. **DO NOT** use air impact tools to tighten fasteners on Borla Performance Exhaust Systems. Use of such tools may result in bent flanges or gasket contact areas leading to exhaust leaks.

1. Using the original gaskets and hardware, place the front muffler assembly in position as shown in figure 8. Secure the flanges to the vehicle manufacturer's recommended torque value.
2. Install the clamp portion of the exhaust bracket shown in figure 9 and secure to the vehicle manufacturer's recommended torque value.



Figure 8

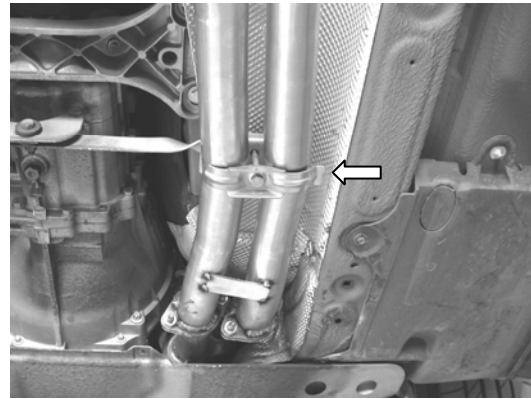

Figure 9

3. Using the original hardware, install rear center support as shown in figure 10 onto mid muffler assembly.
4. Place a clamp over the expanded ends of the mid muffler assembly and place it into position as shown in figure 11. **DO NOT** tighten the clamps. Using the original hardware, secure the rear center support to the vehicle.



Figure 10



Figure 11

5. Using the original hardware, install front center support bracket as shown in figure 12.
6. Place a clamp over the expanded ends of rear muffler assembly and set it into position as shown in figure 13 installing the hangers into the rubber brackets. **DO NOT** tighten the clamps.

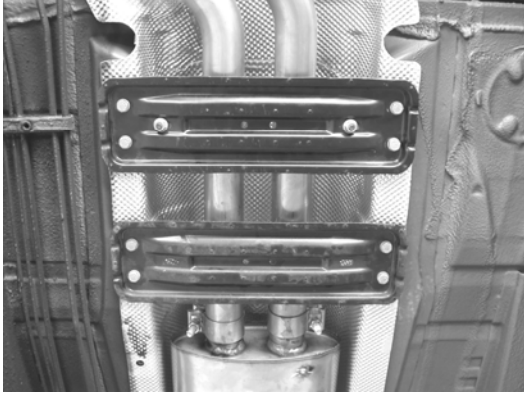

Figure 12



Figure 13

7. Check your exhaust system for proper clearance under the vehicle and also for tip alignment.
8. Once position has been determined to be correct, tighten the Accuseal™ clamps to 32-35 ft. lbs. from the rear of the vehicle to the front.
9. Before starting your vehicle, make sure to check all wires, hoses, brake lines, body parts and tires for safe clearance from the exhaust system.
10. Start vehicle and check for any leaks. If any leaks are found, determine cause (such as loose or incorrectly positioned clamp) and repair as necessary.

Note: When you first start your vehicle after the installation of your new Borla Performance Exhaust System, there may be some smoke and fumes coming from the system. This is a protective oil based coating used in the manufacturing of mandrel bent performance exhaust tubing. This is not a problem and will disappear within a very short period of time after the exhaust has reached normal operating temperatures.



Congratulations!!! You have completed the installation of the world famous Borla Performance Stainless Steel Exhaust System.